

NOORDGEVEL (ZUIDE NEEDE BERG)

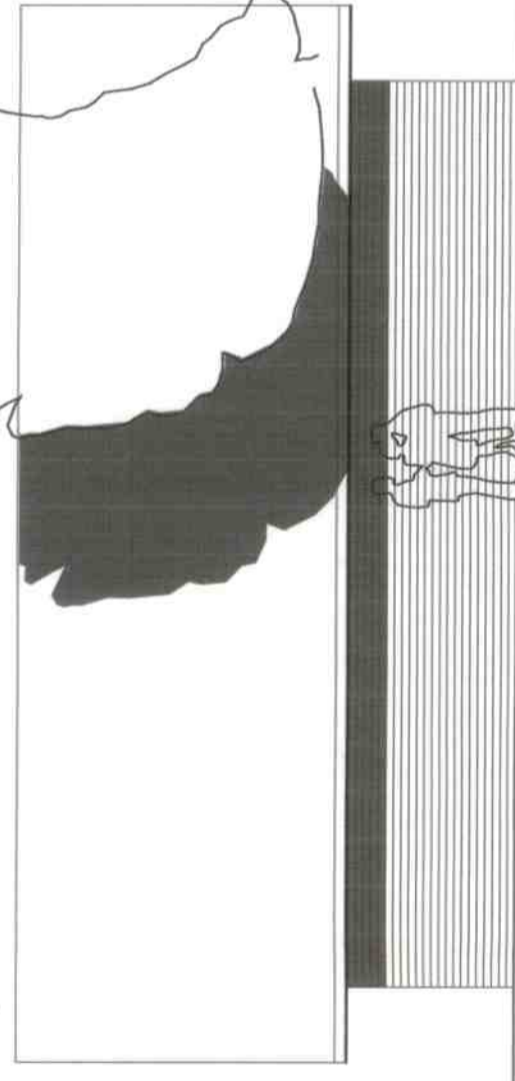

OOSTGEVEL

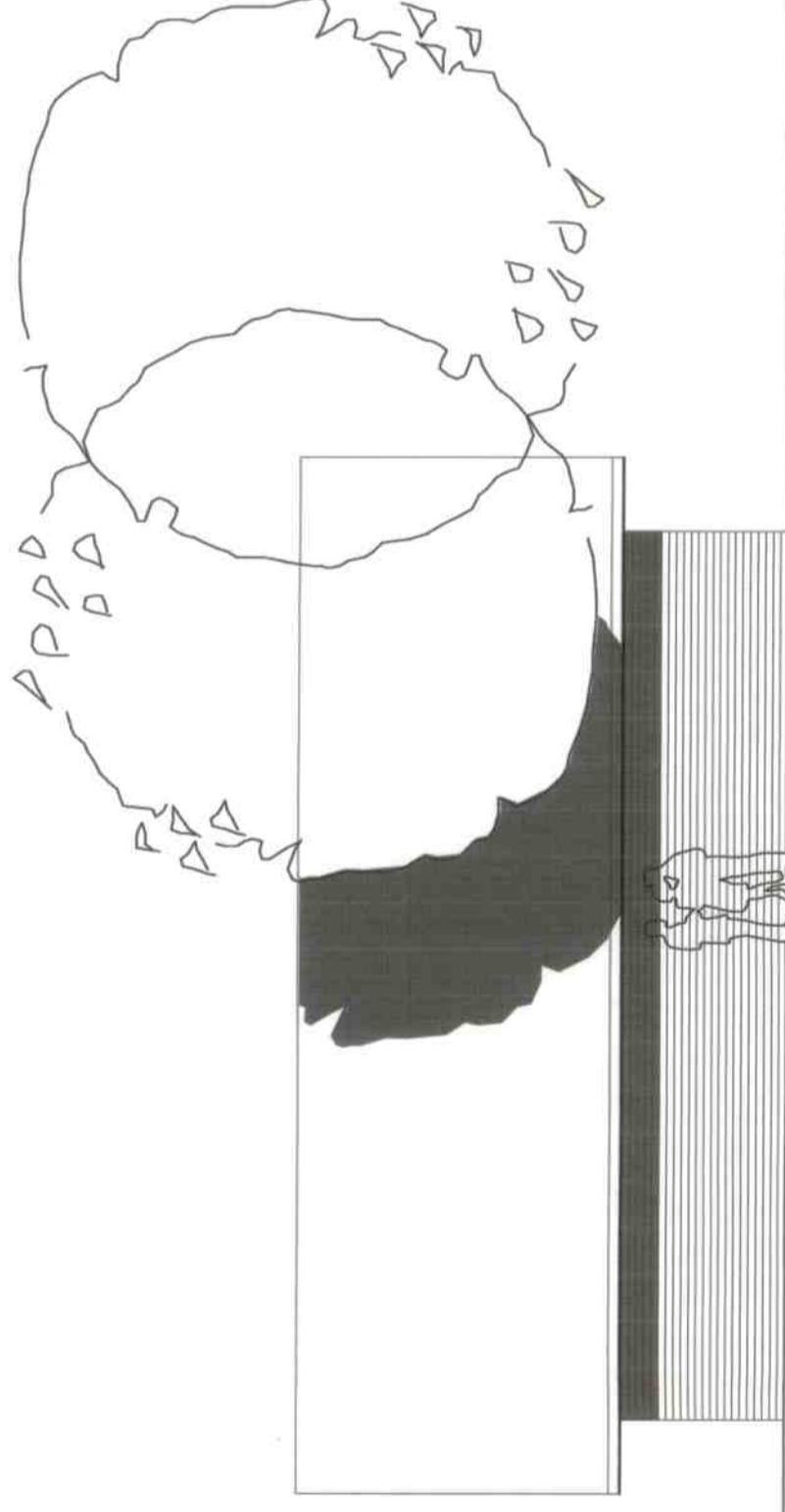
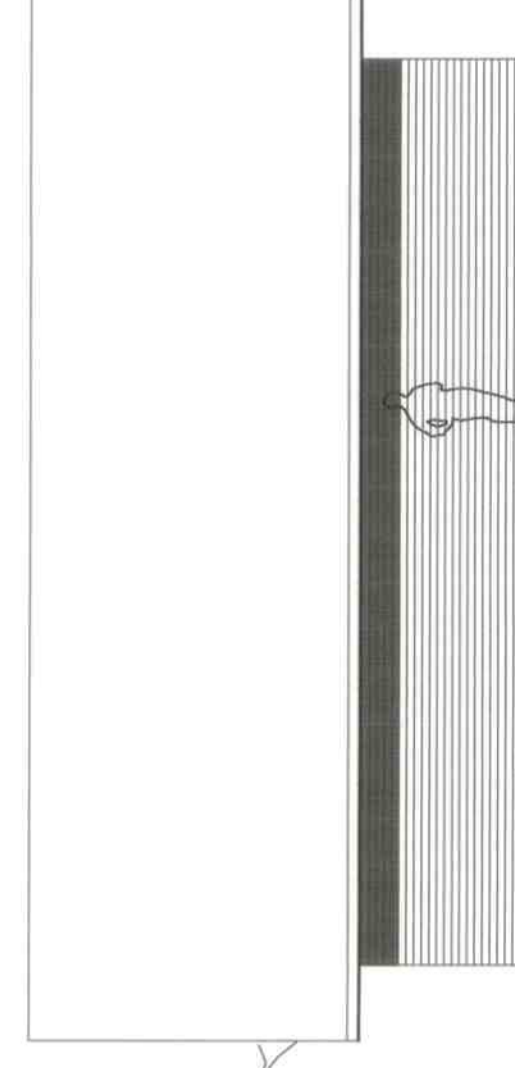
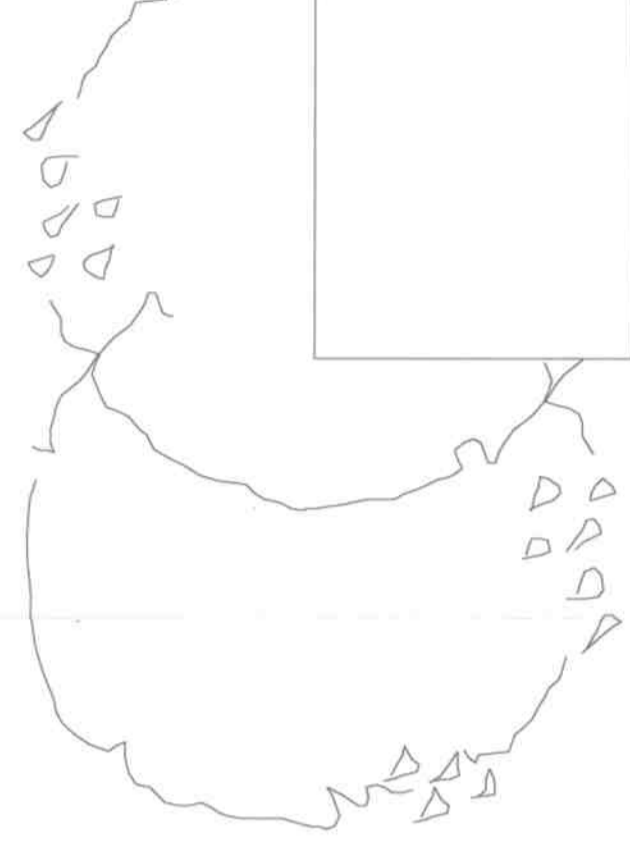

WESTGEVEL (ERFZIJDE)

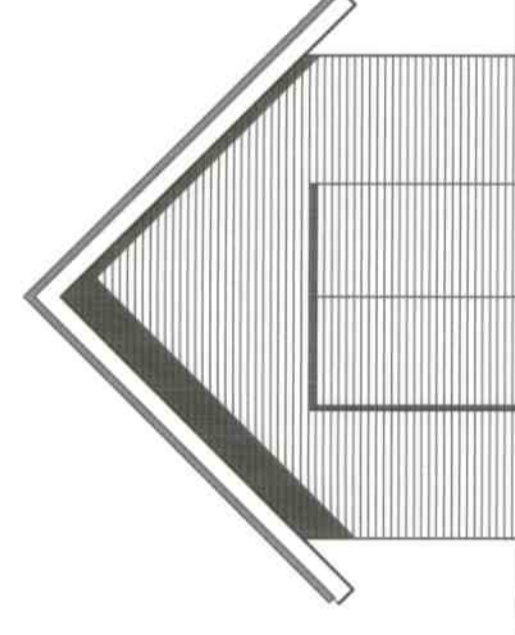

ZUIDGEVEL (STRAATZIJDE)

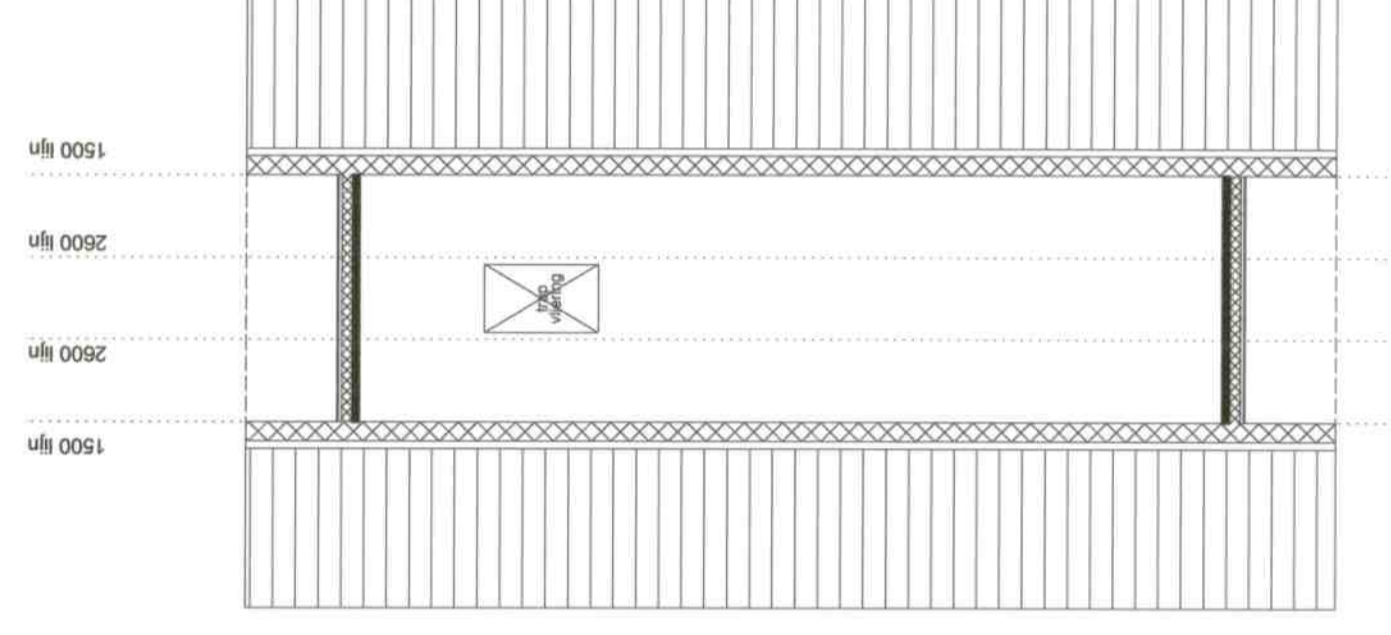

ZOLDER

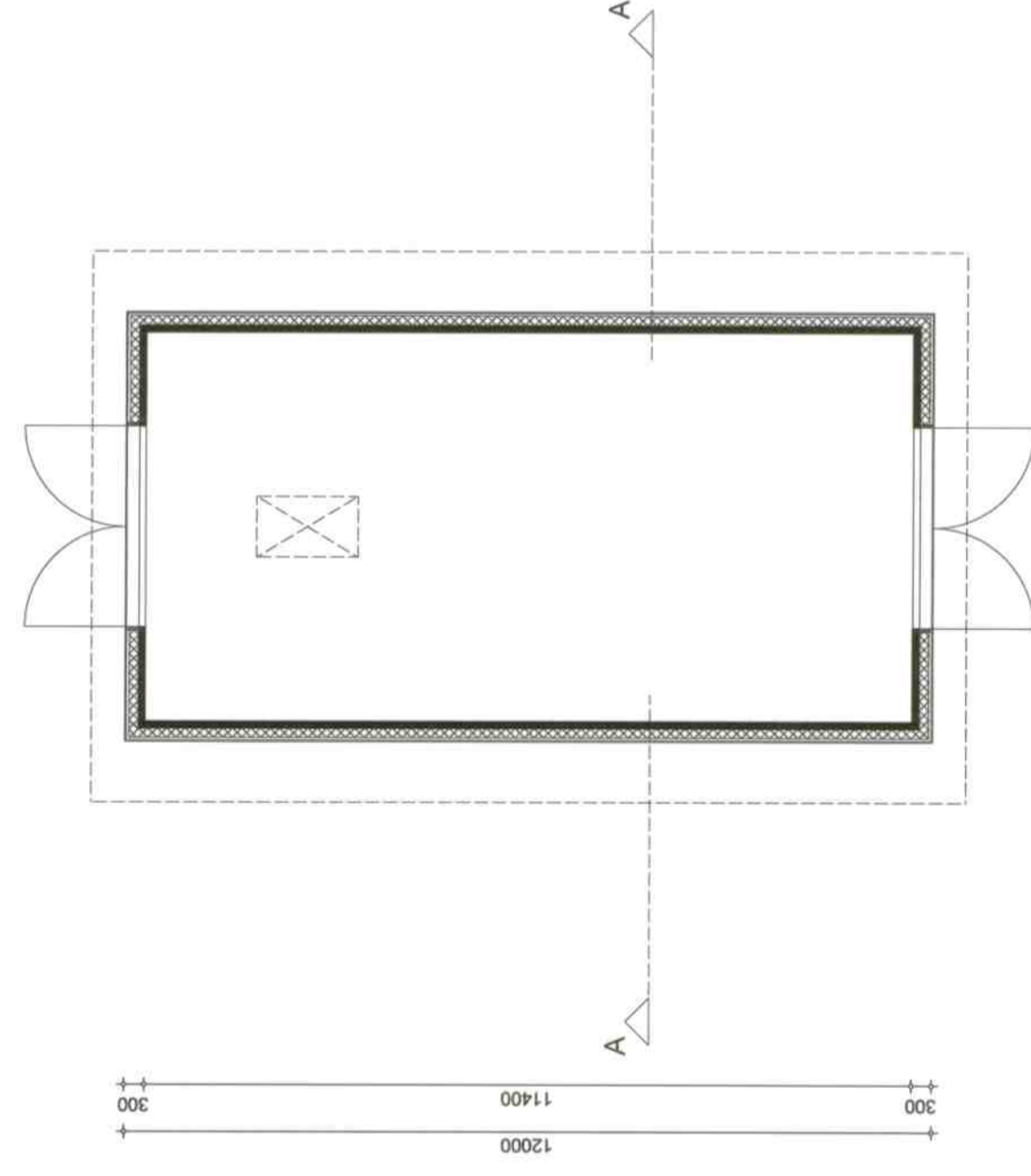

BEGANE GROND

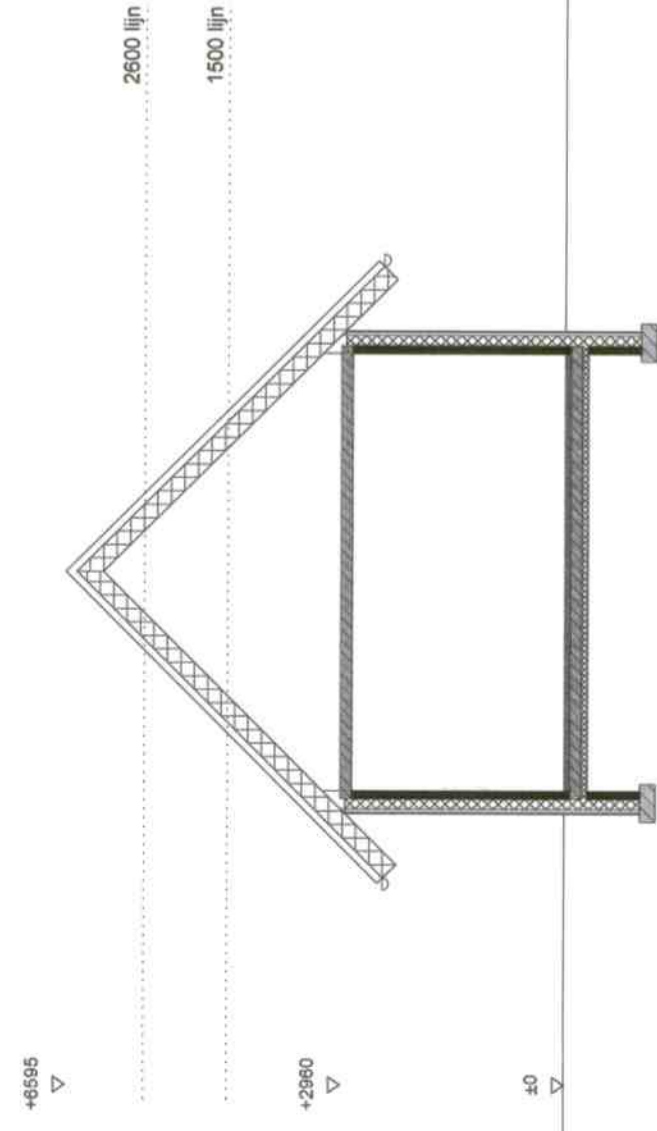

DOORSNEDE AA

Gemiddeld
Ingekomen
17 APR 2010

kleurenschema

wanden	hout (binnen verkozamen)
deuren	hout
ramen	hout
pannen	keramiek
dagbodem	zink
vloerbedekking	keramiek
lestoepsels	kunststeen

antraciet
wit
wit
antraciet
natuur
zwart

Behoort bij besluit van
burgemeester en wethouders
van Berkeland d.d. 31 AUG 2010
nummer: B 1 2 0 1 0 1 1

nieuwbouw woning G.L. Rutgersweg 6B Noordijk

plattegronden, doorsneden
en gevelcaziëchten

Werkenummer:
09168

Bouwnummer:
DO-2

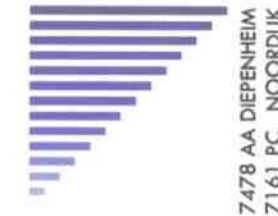

Schaal	1:1000
Ontwerp	25.03.2010
Uitvoering	
Tekening	05.07.15.07.05
Mobiel	06.12.27.16.02
Foto	05.07.2010
Beoordeling	05.07.2010
Beoordeling	05.07.2010
Beoordeling	05.07.2010
Beoordeling	05.07.2010

Architect	G.L. Rutgersweg 6
TRADAM / DE BUIJW ARCHITECTEN W. Brouwer	G.L. Rutgersweg 6
Gemeneer 19	71043 291 883
1,0547 352 000	71043 291 883
1,0547 352 000	71043 291 883

Bouwtechnisch bureau Arian Schuiten

G.L. Rutgersweg 11
7104 PC NOORDIJK