

**Behoort bij besluit van burgemeester en wethouders van Berkelland**

**datum: 7 okt 2015**

**zaaknr: 133774**

**AB-nr: AB 2015033**

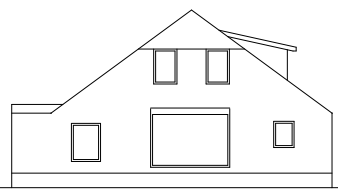

Voorgevel bestaand

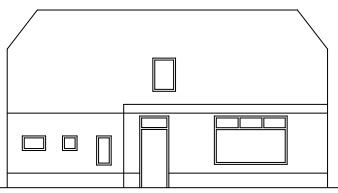

Linkerzijgevel bestaand

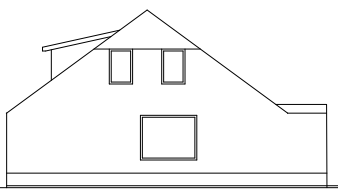

Achtergevel bestaand

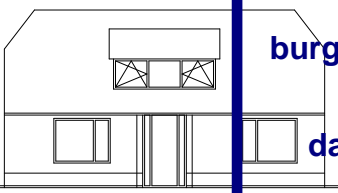

Rechterzijgevel bestaand

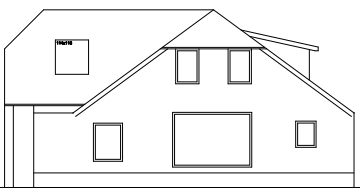

Voorgevel gewijzigd

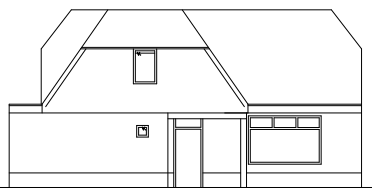

Linkerzijgevel gewijzigd

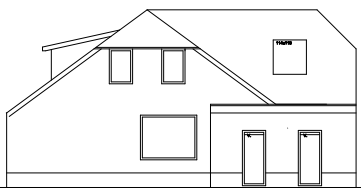

Achtergevel gewijzigd

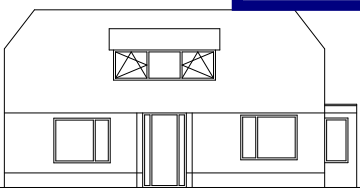

Rechterzijgevel gewijzigd

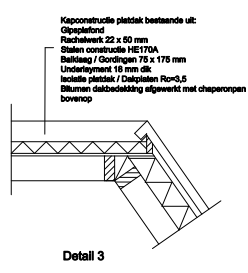
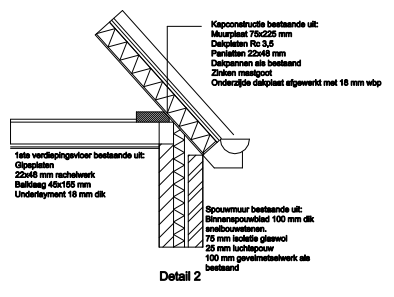
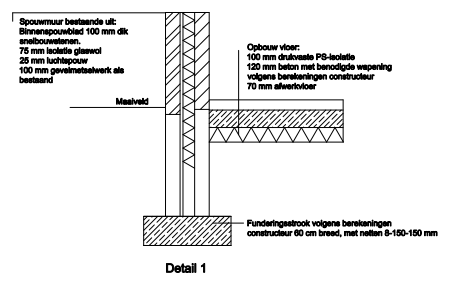
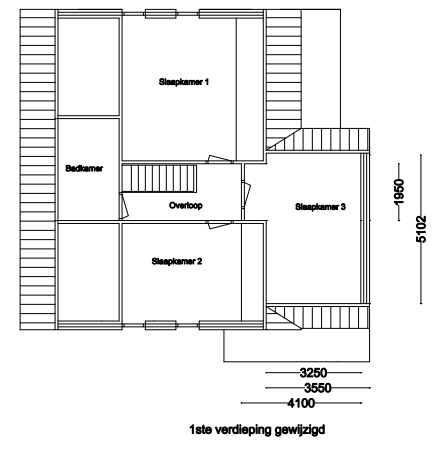
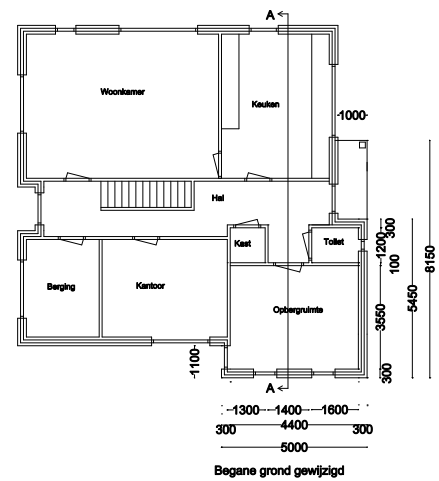
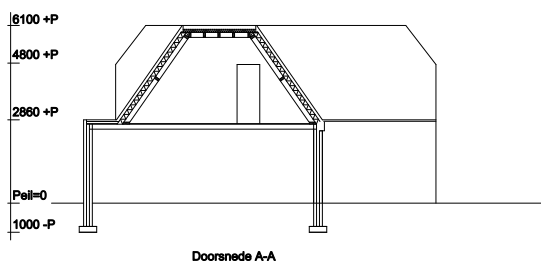

V. = Ventilatorcoester DucoFIT 50 ZR

Werk: Verbouwing Fam. Landwee	
Adres: Voorste Russchemorsdijk 6	
Plaats: 7165 AA Rietmolen	
Gemeente: Berkelland	
Schaal: 1:100/ 1:20	Formaat: A1
Datum: 31-1-2015	Getekend: AV
Gewijzigd: 11-4-2015	
Gewijzigd: -	

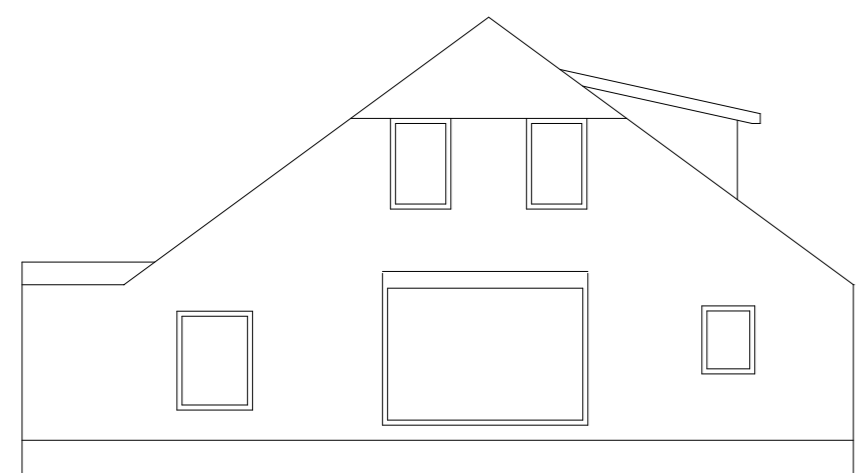

Voorgevel bestaand

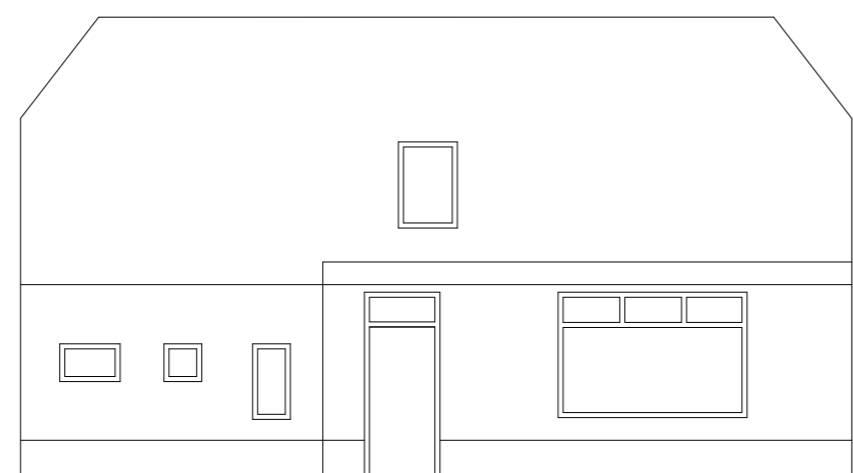

Linkerzijgevel bestaand

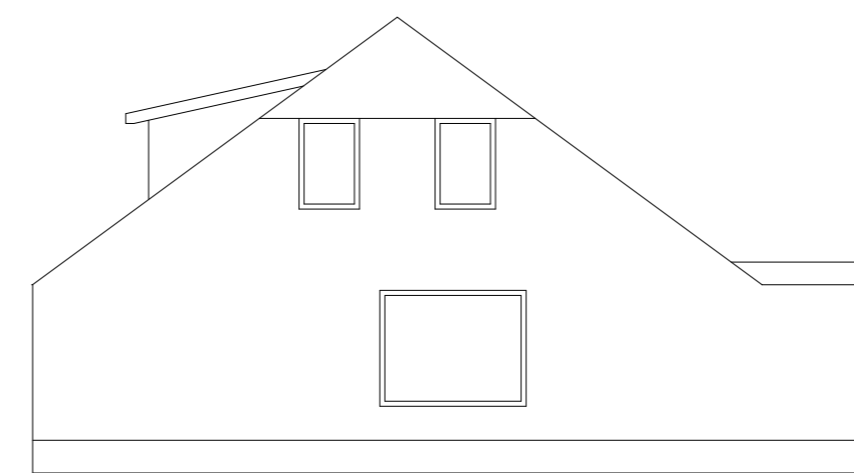

Achtergevel bestaand

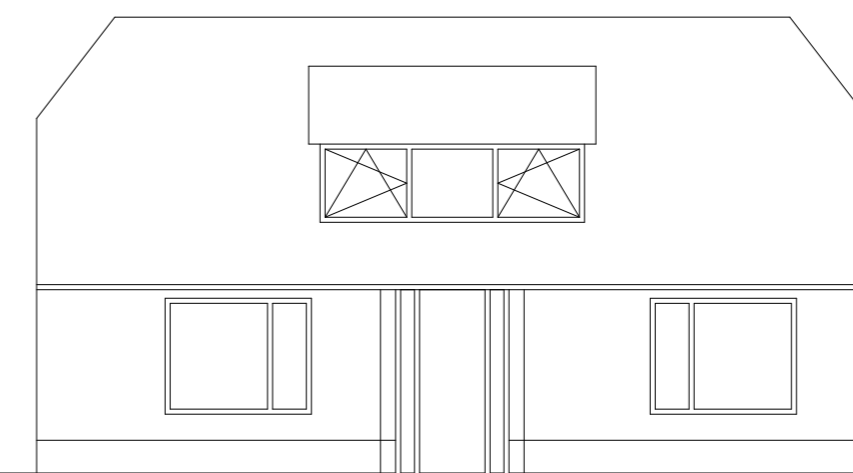

Rechterzijgevel bestaand

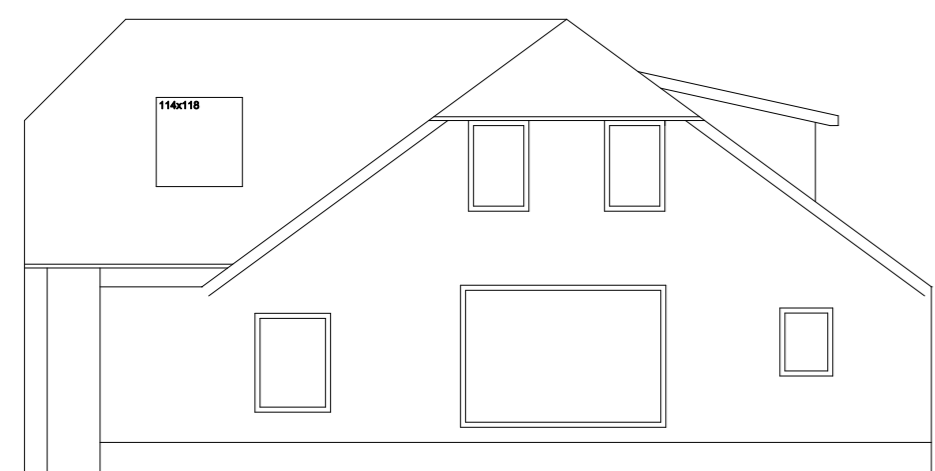

Voorgevel gewijzigd

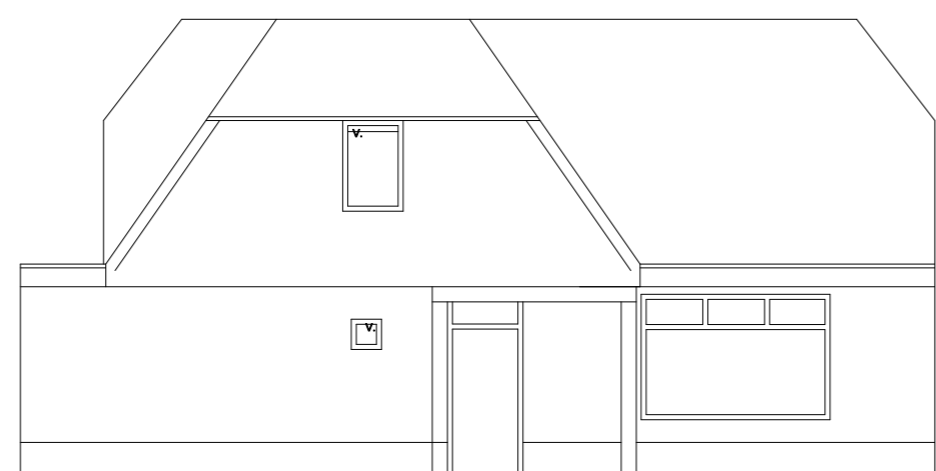

Linkerzijgevel gewijzigd

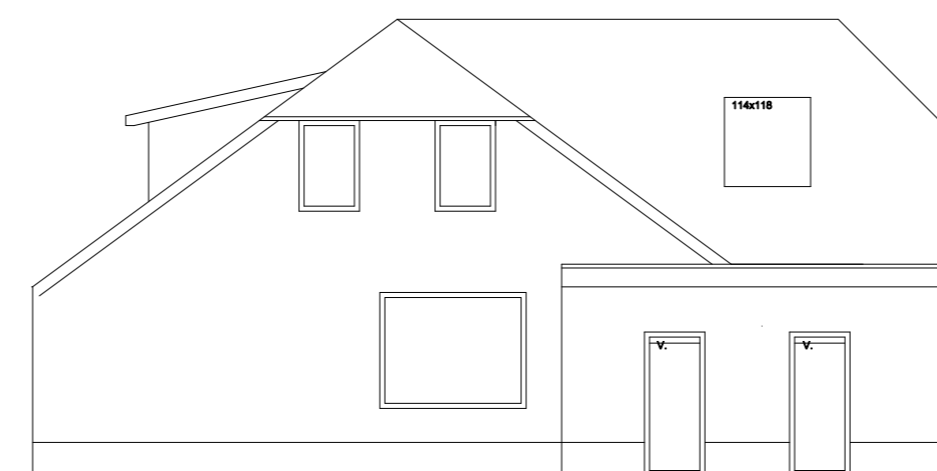

Achtergevel gewijzigd

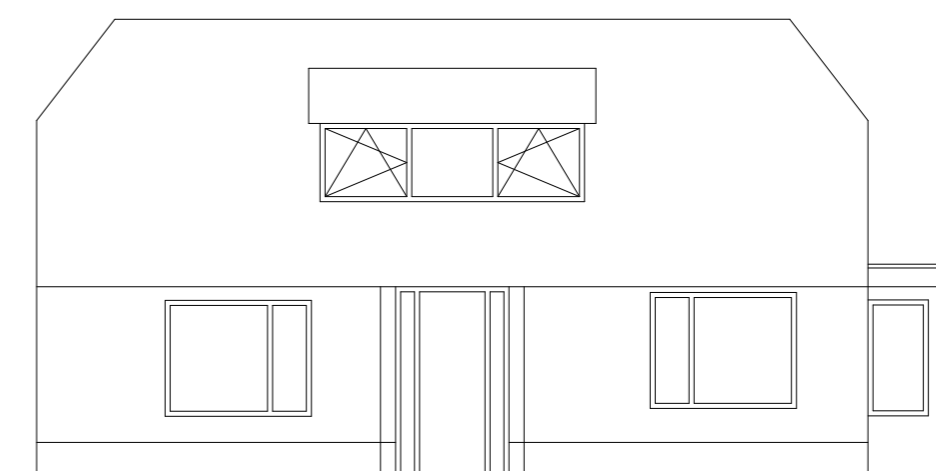

Rechterzijgevel gewijzigd

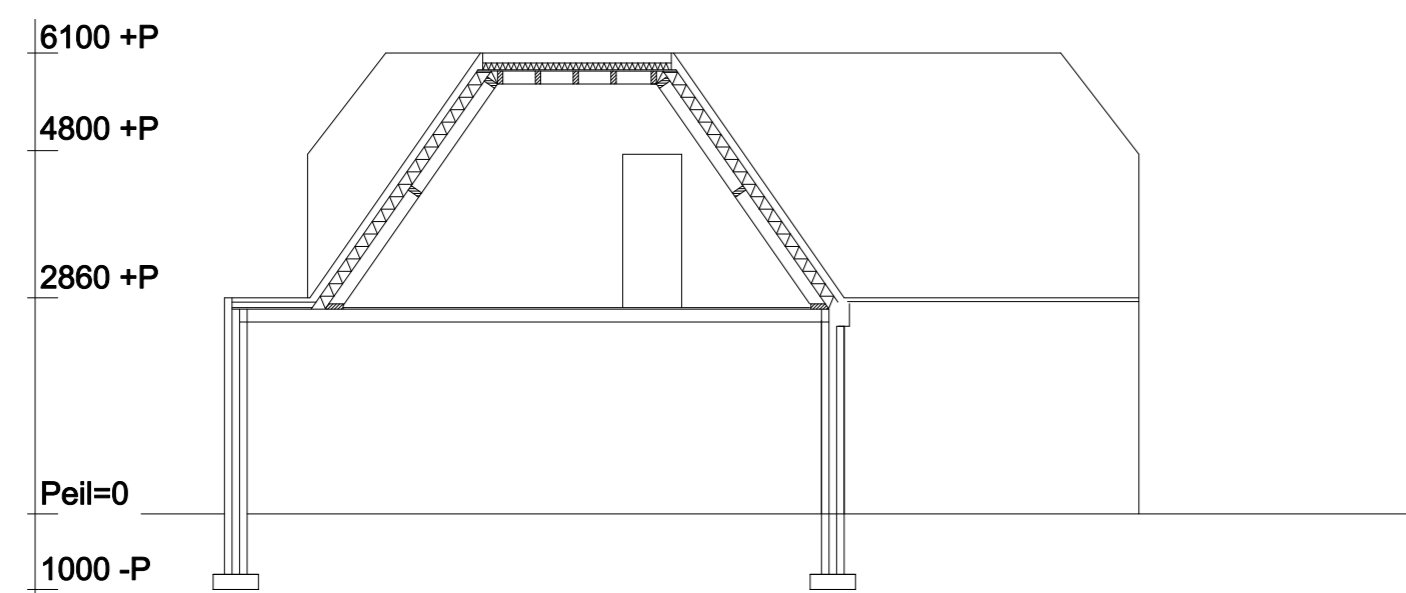

Doorsnede A-A

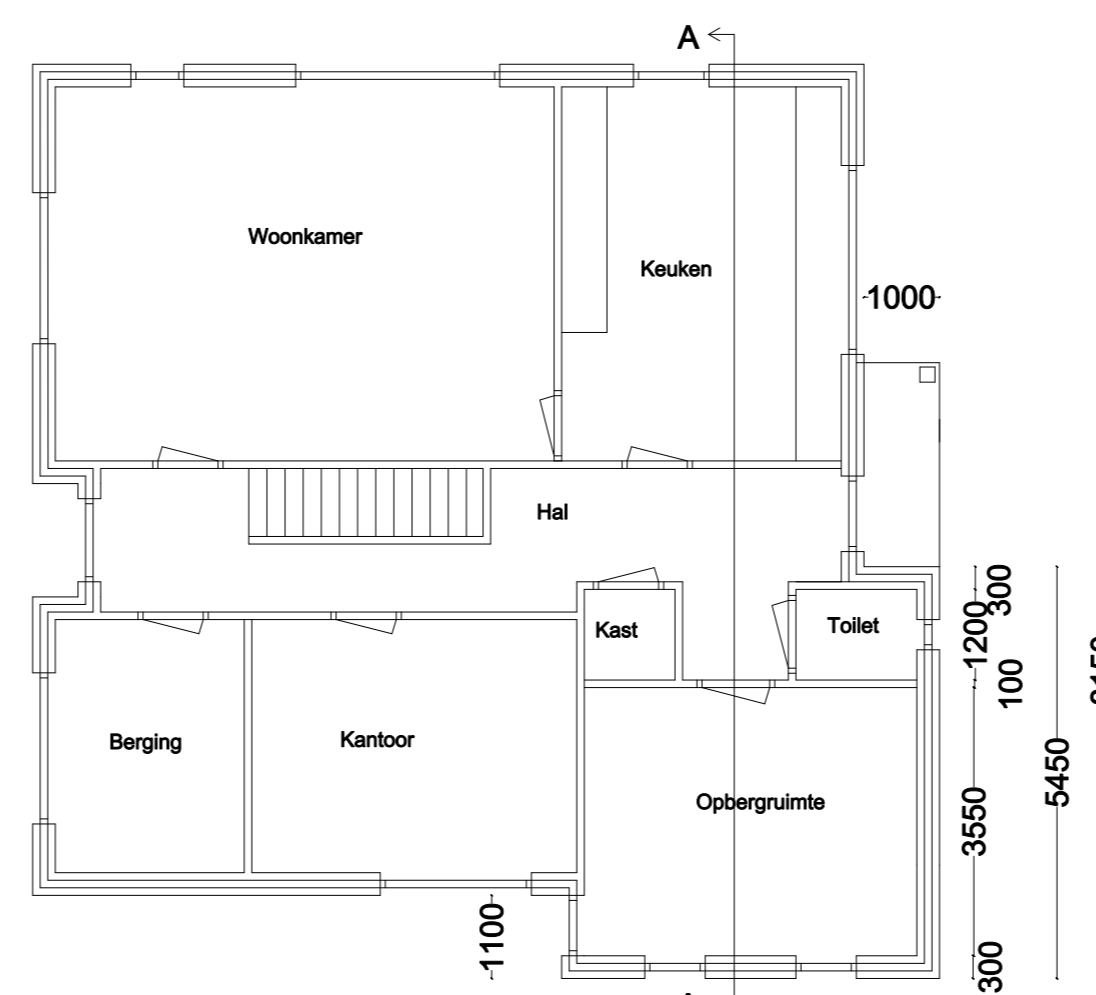

Begane grond gewijzigd

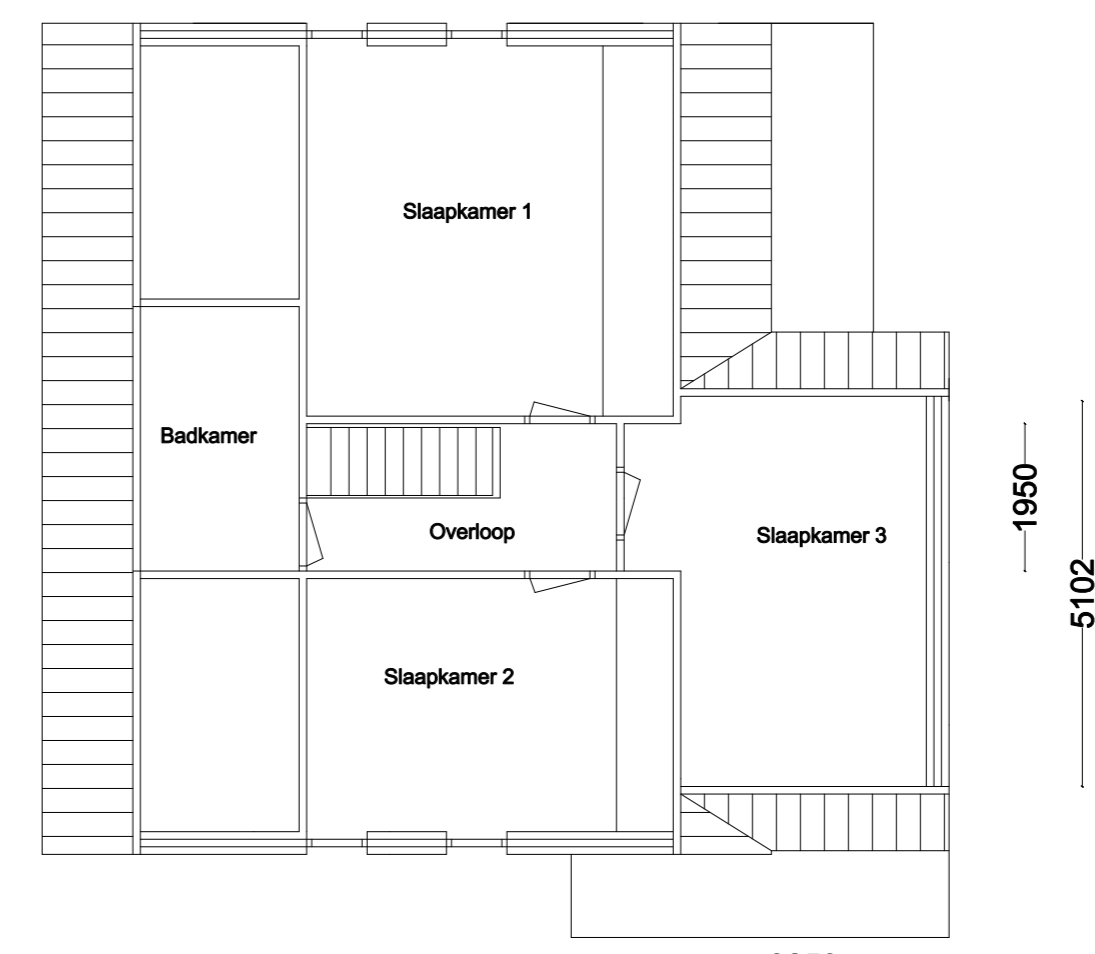

1ste verdieping gewijzigd

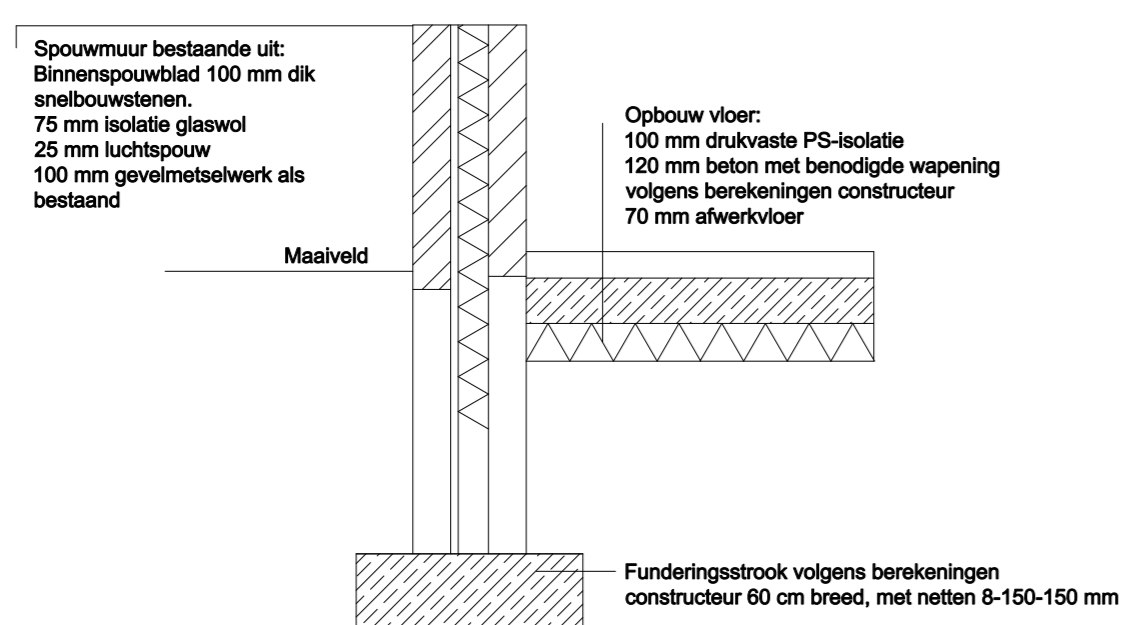

Detail 1

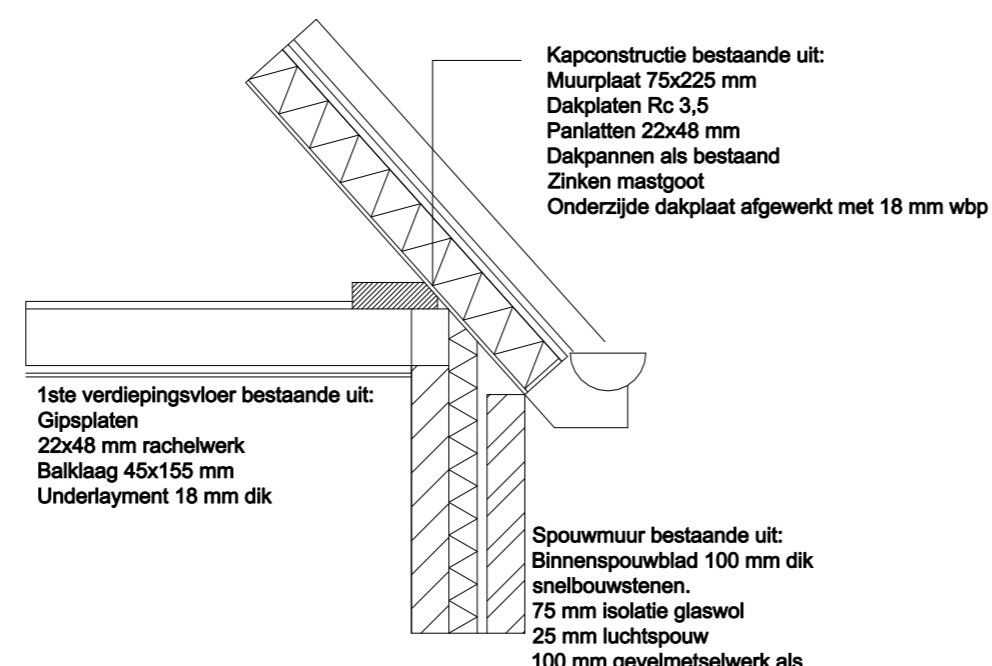

Detail 2

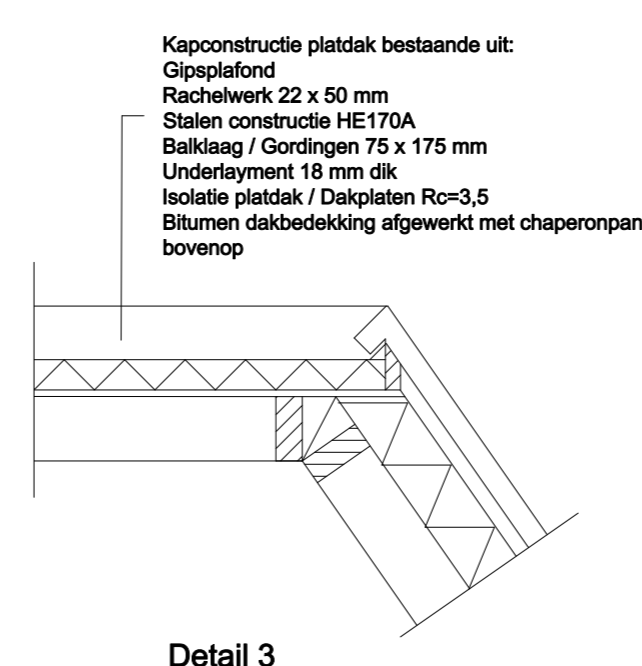

Detail 3

V. = Ventilatiooroster DucoFit 50 ZR

Werk: Verbouwing Fam. Landewee	
Adres: Voorste Russchemorsdijk 6	
Plaats: 7165 AA Rietmolen	
Gemeente: Berckeland	
Schaal: 1:100/ 1:20	Formaat: A1
Datum: 31-1-2015	Getekend: AV
Gewijzigd: 11-4-2015	
Gewijzigd: -	